

INSTALLATION GUIDE

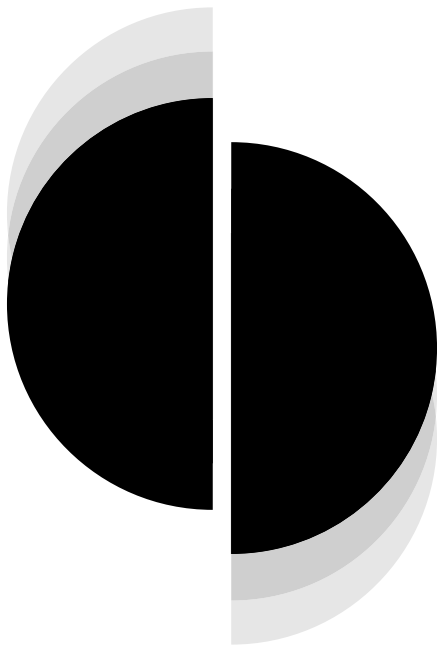

R SERIES

LATCH

Welcome to your smartest install yet.

Latch R is a proximity reader, keypad, and wireless entry system, that can be operated as a standalone device or be connected to a panel as part of a wider system.

Things you should know

1. Only use screws provided. Other screws can cause Latch R to disengage from the mounting plate.
2. The relay will revert to an open state in the event of power failure. Take precautions when wiring fail-safe locking hardware.
3. Apply power only after all devices have been properly connected.
4. Configuration requires the iOS Manager App running on an iPhone 5S or newer.
5. Troubleshoot at **support.latch.com**

Wiring

Standalone Wiring

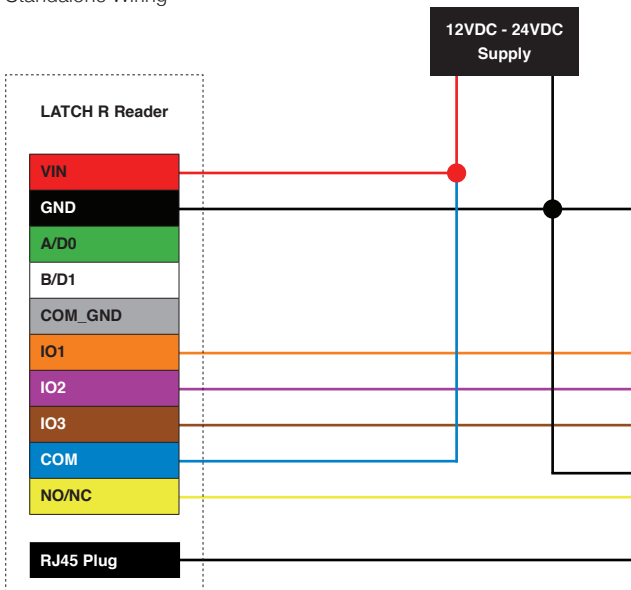

Minimum Wiring Recommendations

Distance		< 50ft	< 200ft	< 500ft	< 1000ft
Power	12V	22AWG	20AWG	18AWG	14AWG
	24V	22AWG	20AWG	20AWG	20AWG
Relay		22AWG	20AWG	18AWG	

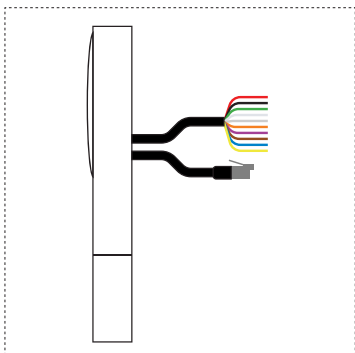
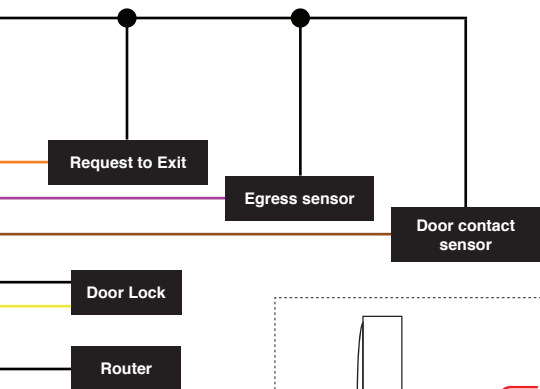

Wiring

Panel Wiring

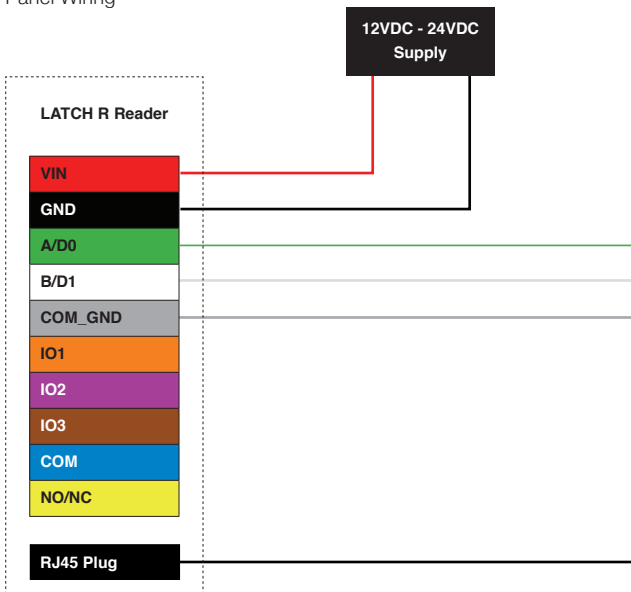





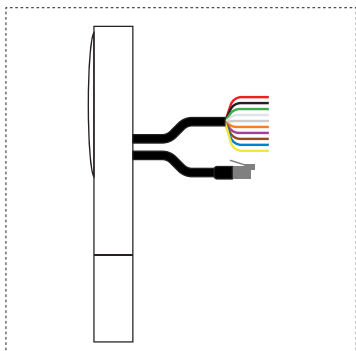
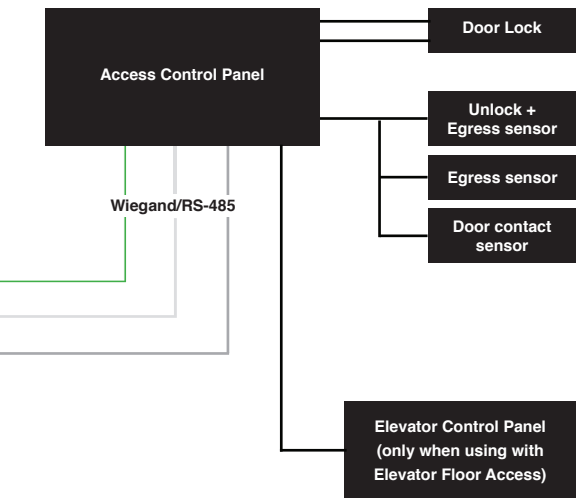





Minimum Wiring Recommendations

Distance		< 50ft	< 200ft	< 500ft	< 1000ft
Power	12V	22AWG	20AWG	18AWG	14AWG
	24V	22AWG	20AWG	20AWG	20AWG
Wiegand (Shielded)		22AWG	22AWG	20AWG	20AWG











Wiring

Standard Reader Connections

	Wire Color		Name	Description
1	GREEN		A/D0	RS-485 A, Wiegand DATA0
2	WHITE		B/D1	RS-485 B, Wiegand DATA1
3	GRAY		COM_GND	Return for A/D0, B/D1 wires
4	YELLOW		NO/NC	Relay contact
5	BLUE		COM	Relay contact
6	ORANGE		IO1	Input/Output
7	PURPLE		IO2	Input/Output
8	BROWN		IO3	Input/Output
9	RED		VIN	12VDC to 24VDC power input
10	BLACK		GND	Return for power input

Ethernet Connections

	Wire Color		Name
11	GREEN/WHITE		TX+
12	GREEN		TX-
13	ORANGE/WHITE		RX+
14	BLUE		SPR1
15	BLUE/WHITE		SPR2
16	ORANGE		RX-
17	BROWN/WHITE		SPR3
18	BROWN		SPR4

Technical Specifications

Mechanical

- Dimensions: 5.49" x 3.18" x 0.76"

Wireless Communication

- Near Field Communication (NFC): ISO 14443A
- NFC Card Type: Mifare Classic
- Bluetooth: BLE 4.2 (iOS and Android compatible)
- Wi-Fi: 802.11 b/g/n

Wired Communication

- Ethernet 10/100Mbps, RJ45 Plug
- Serial: RS-485, 5VDC
- Wiegand (26-bit) Data0, Data1, 5VDC 25mA source each

Power

- Class 2 Isolated, UL Listed Power Supply
- Supply Voltage: 12VDC to 24VDC
- Operating Power: 6W (0.5A @12VDC, 0.25A @24VDC)
- For UL 294 installations, the power source must be compliant to one of the following standards: UL 294, UL 603, UL 864, or UL 1481. For ULC 60839-11-1 installation, the power source must be compliant to one of the following standards: ULC S304 or ULC S318.
- DC input evaluated for UL294: 12V DC – 24V DC.

Interface

- 1 x Lock Relay: Configurable SPST NO
- 3 x Input or Output (input: normally low; output: open drain)

Camera

- 135 degree wide capture

Environmental

- Temperature: Operating / Storage -40°C to 66°C
- Operating Humidity: 93% at 32°C, non-condensing
- Environmental: IP65 | IK04

Compliance

- FCC Part 15 (US)
- IC RSS (Canada)
- UL 294
- UL/CSA 62368-1
- RoHS

Warranty

- 1-year limited warranty on electronic components
- 5-year limited warranty on mechanical components

Drill

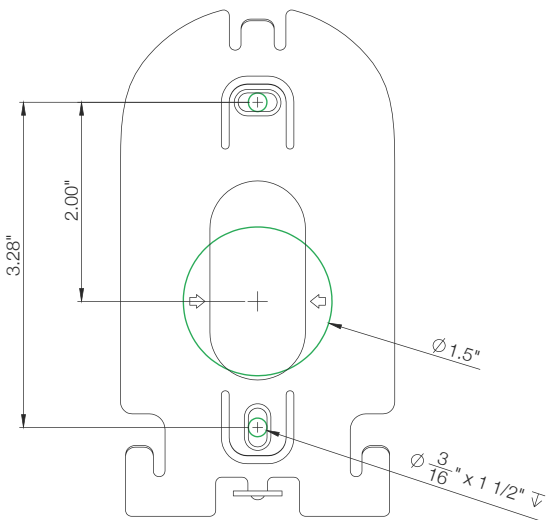

1

Prepare holes using mounting plate as a template and drill.

Screw

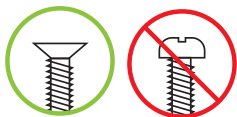

Important: Use the provided screws or #6 flathead screws to avoid mounting failure.

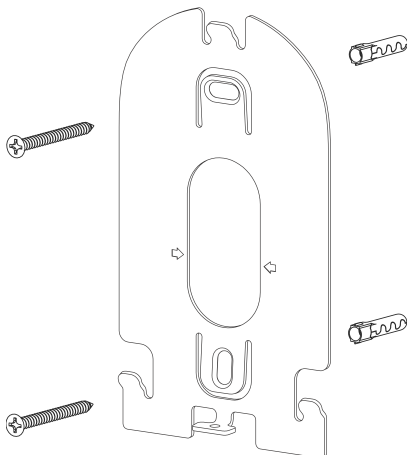

2

Screw mounting plate in using the correct screws.

Connect

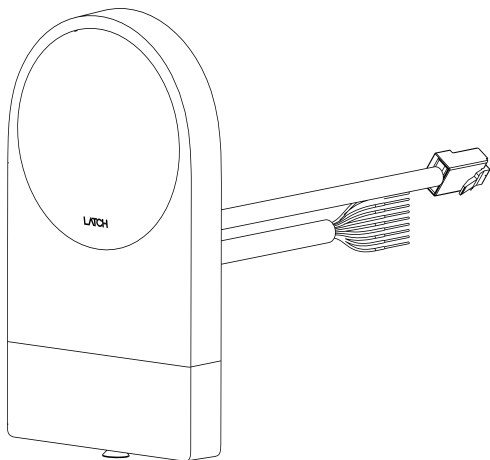

3

Connect based on wiring diagrams.

Configure

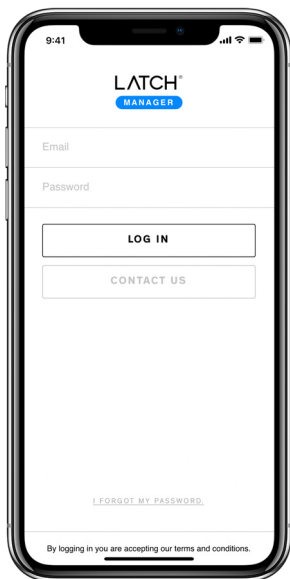

4

Download Latch Manager App from the iOS App Store to configure Latch R and test that everything works. Requires iPhone 5S or newer. Learn more at support.latch.com

Mount

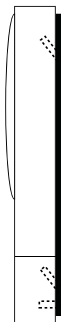
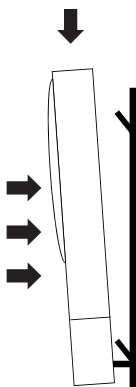
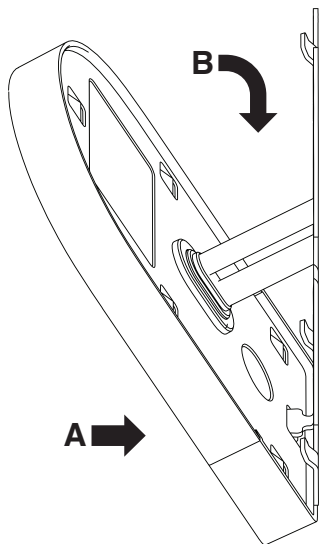

5

A. Insert bottom locking tab of mounting plate into Latch R.

B. Place Latch R flush with mounting plate and slide down until all mounting tabs fit snugly.

Secure

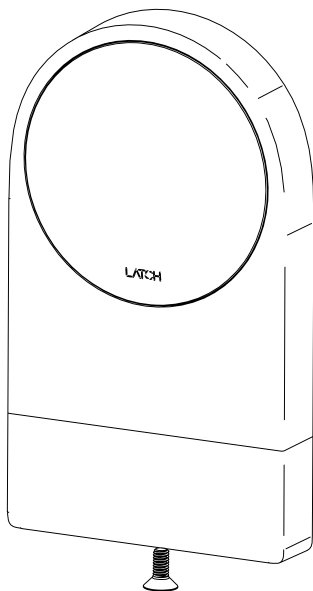

6

Tighten security screw to secure.

Regulatory Compliance

Federal Communications Commission (FCC) Compliance Statement

This device complies with part 15 of the FCC Rules. Operation is subject to the following conditions:

(1) This device may not cause harmful interference and (2) this device must accept any interference received, including interference that may cause undesired operation.

CAUTION: Changes or modifications not expressly approved by the manufacturer responsible for compliance could void the user's authority to operate the equipment.

NOTE: This equipment has been tested and found to comply with the limits for a Class B device, pursuant to part 15 of the FCC Rules. These limits are designed to provide reasonable protection against harmful interference in a residential installation. This equipment generates, uses and can radiate radio frequency energy and if not installed and used in accordance with the instructions, may cause harmful interference to radio communications. However, there is no guarantee that interference will not occur in a particular installation. If this equipment does cause harmful interference to radio or television reception, which can be determined by turning the equipment off and on, the user is encouraged to try to correct the interference by one or more of the following measures:

- Reorient or relocate the receiving antenna
- Increase the separation between the equipment and receiver

- Connect the equipment into an outlet on a circuit different from that to which the receiver is connected
- Consult the dealer or an experienced radio/TV technician for help

Industry Canada (IC) Compliance Statement

Operation is subject to the following two conditions:

1. This device may not cause interference, and
2. This device must accept any interference, including interference that may cause undesired operation of the device.

To satisfy RF exposure requirements, this device and its antenna must operate with a separation distance of at least 20 centimeters from all persons and must not be colocated or operating in conjunction with any other antenna or transmitter.

Le présent appareil est conforme aux CNR d'Industrie Canada applicables aux appareils radio exempts de licence. L'exploitation est autorisée aux deux conditions suivantes :

1. l'appareil ne doit pas produire de brouillage, et
2. l'appareil doit accepter tout brouillage radioélectrique subi, même si le brouillage est susceptible d'en compromettre le fonctionnement.

Pour remplir les conditions requise sur l'exposition des fréquences radios, cet appareil et les antennes doivent fonctionner avec une distance minimum de 20 centimètres avec toutes les personnes et ne doivent pas être placés ou fonctionner en conjonction avec tout autre antenne ou émetteur.

Safety instructions

- This product shall be installed and serviced by certified professionals only.
- The product is intended to be used as either a standalone access control system or as a reader with a panel. Multiple Latch R devices cannot be used to control a single access point.
- Locations and wiring methods shall be in accordance with the National Electrical Code, ANSI/NFPA 70.
- There are no replacement parts available for this product.
- Outdoor electrical boxes used for mounting are recommended to be NEMA 3 or better.
- Correct wiring insulation should be used during installation to prevent the risk of electrical shock.
- For UL compliant installations, UL requirements listed in this manual supersede conflicting information.

Testing and Maintenance Operation

Prior to installation, ensure that all wiring is secure. Each unit should be checked annually for:

- Loose wiring & loose screws.
- Normal operation (attempt to unlock with all possible methods).

Impaired Operation

Units are designed to operate under adverse environmental conditions. Under normal circumstances, they will function properly regardless of outside conditions. However, units do not have secondary power sources and cannot function without direct continuous power. If a unit is damaged by natural causes or deliberate vandalism, it may not function properly depending on the level of damage.

Electronic Specifications

Latch R offers support for the following credentials:

- Near Field Communication (NFC): ISO 14443A.
- NFC Card Type: Mifare Classic.
- Bluetooth: BLE 4.2 (iOS and Android compatible).
- Maximum BLE distance of 10m.
- 7 digit passcode.

Configured as a reader, the Latch R can work with Brivo ACS6000, Keyscan EC1500, Keyscan EC2500 and many other access control panel systems.

Device requirement for setup

- 64 bit iOS device
- Latest version of the Latch Manager App

Software Information

- The Latch app is necessary for BLE unlocks and the manager app is necessary to configure the Latch R.
- The device using the Latch app to unlock the product can only be used in the same manner as a physical credential, transmitting user data to the reader interface within close proximity.
- The device using the Latch app should employ a means of verification such as a pin or biometric feature to unlock the device before using the Latch app.
- Access logs on the Manager app are able to distinguish the type of unlock that was done on the device (NFC, Bluetooth, Proximity, Passcode).
- Certification was acquired with Latch app v.2.5.0.

Troubleshooting

If lock does not operate:

- Ensure the lock is powered with DC power. Do not use AC power.
- Ensure the input voltage is between 12 and 24 volts DC.
- Further troubleshooting information is available on the support website at support.latch.com

Firmware Version

- Latch R has been tested for UL294 compliance employing firmware version R2.2.1.
- The current firmware version can be checked by using the Latch Manager app.
- Further programming information can be found on the support website at support.latch.com.

UL 294 Access Control Performance Ratings:

Feature Level Destructive Attack	Level II
Line Security	Level I
Endurance	Level I
Standby Power	Level I
Single Point Locking Device with Key Locks	Level I

Input/Output Options

All inputs/outputs may be configured for normally open or normally closed contacts. Refer to the wiring diagram for the acceptable wiring configurations.

Request-to-exit

Request to exit can be setup by configuring the IOs while in use as a standalone system or configuring the access control system while configured as a reader with a panel. Please refer to the installation wiring diagrams for further information.

Normal Product Operation

Condition	Indication
Normal Standby	All indicator LEDs off, keypad not illuminated.
Authenticating User	Top indicator LED illuminated.
Access Granted	Audible buzzer, all indicator LEDs illuminate and power down in a clockwise animation.
Access Denied	Keypad LEDs blink multiple times.
Keypad Active	Keypad LEDs illuminated.

- For controlled, protected, and/or restricted areas, access control on a user basis can be configured with the Latch Manager application.
- The keypad activates when a finger is detected and serves as a touch screen input to enter passcodes for unlocking the device.
- Indicator LEDs serve to indicate digits input for a passcode, and access granted or denied.

Credential Type & Transmission Technology

Credential bit format and length: Passcodes used to unlock the device consist of 7 digits ranging from 0-9. NFC cards have 37 bit format and the wiegand output is 26 bit.

Fail-safe/fail-secure operation: Fail-safe/fail-secure can be setup by configuring the relay as either normally closed or normally open. Normally open allows fail-safe operation while normally closed allows fail-secure operation.

Configuration & Commissioning Instructions

Configuration & Commissioning instructions can be found in more detail in the Technical Certification Training as well as on the support website at support.latch.com.

Service Information

Service Information can be found in more detail in the Technical Certification Training as well as on the support website at support.latch.com.

Applicable Products

This installation guide applies to products with the following designators on the label:

- **Model:** R2 (FCC ID: 2AK5B-R2 | IC ID: 22134-R2)

LATCH

Document Number: 770-00010 v1.6
Revised On: 05/07/2020